

Article number: 12737000050100

Description: KLEE-coil 737 000 050.100
M5 Steel

Measures

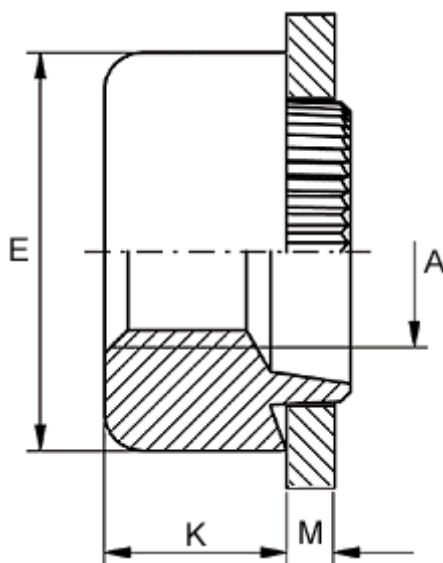

Female thread A	= M5
Height K	= 4.0
Outer diameter E	= 9.0
Plate thickness	= 4.7 to 4.9
Recommended bore diameter +0.05	= 7.0